





# Pocket FM Radio with Ear Buds

12-827

OWNER'S MANUAL — Please read before using this equipment.

## ! IMPORTANT !

If an icon appears at the end of a paragraph, go to the box on that page with the corresponding icon for pertinent information.

-  — Warning
-  — Caution
-  — Important
-  — Hint
-  — Note

## WARNING

Dispose of old batteries promptly and properly. Do not burn or bury them.

## CAUTION



- Use only fresh batteries of the required size and recommended type.
- If you do not plan to use the radio for a week or more, remove the batteries. Batteries can leak chemicals that can destroy electronic parts.

## NOTE

The radio stops searching for frequencies at 108MHz.

Your RadioShack Pocket FM Radio with Ear Buds lets you listen to FM radio privately and conveniently. Its built in micro flashlight lets you read books, maps or see objects clearly in an area with insufficient light. Its small size and convenient belt clip make it easy to carry.

## INSTALLING BATTERIES

You need two AAA batteries (not supplied) for power. For the best operation and longest life, we recommend RadioShack alkaline batteries.  

1. Press the ear bud storage compartment cover's tab on at the back of the radio

and push in the direction of the arrow to lift the cover.

2. Remove the ear buds.
3. Push up on the tab close to the bottom of the ear buds storage compartment to lift and remove the battery compartment cover.
4. Insert two AAA batteries into the battery compartment as indicated by the polarity symbols (+ and -) marked inside.
5. Replace the battery compartment cover and close the ear buds storage compartment cover.

## USING THE RADIO

To turn on the Radio, rotate **VOLUME** clockwise until it clicks, then adjust to a comfortable listening level. To turn off the radio, rotate **VOLUME** counterclockwise to **OFF** until it clicks.

Insert the ear bud plug into the earphone jack to connect ear buds to the radio.

Press **SCAN** to automatically tune to the next higher FM station. 

Micro Flashlight

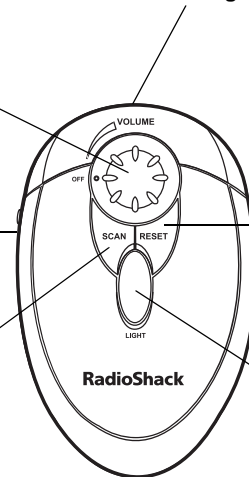

To reset the radio so it begins searching from 88MHz, press **RESET**.

Press **LIGHT** to use the micro flashlight.

## USING THE BELT CLIP

Your radio has a fixed belt clip on the back of it. Simply lift the belt clip and attach it to your belt so you can easily carry it.

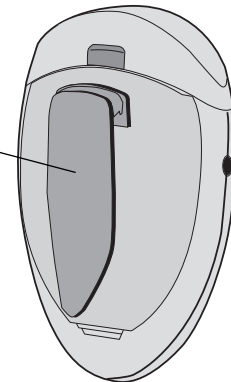

RadioShack®

www.radioshack.com<sup>SM</sup>

© 2002 RadioShack Corporation.  
All Rights Reserved.

RadioShack and RadioShack.com are trademarks used by RadioShack Corporation.

### Limited Ninety-Day Warranty

This product is warranted by RadioShack against manufacturing defects in material and workmanship under normal use for ninety (90) days from the date of purchase from RadioShack company-owned stores and authorized RadioShack franchisees and dealers. EXCEPT AS PROVIDED HEREIN, RadioShack MAKES NO EXPRESS WARRANTIES AND ANY IMPLIED WARRANTIES, INCLUDING THOSE OF MERCHANTABILITY AND FITNESS FOR A PARTICULAR PURPOSE, ARE LIMITED IN DURATION TO THE DURATION OF THE WRITTEN LIMITED WARRANTIES CONTAINED HEREIN. EXCEPT AS PROVIDED HEREIN, RadioShack SHALL HAVE NO LIABILITY OR RESPONSIBILITY TO CUSTOMER OR ANY OTHER PERSON OR ENTITY WITH RESPECT TO ANY LIABILITY, LOSS OR DAMAGE CAUSED DIRECTLY OR INDIRECTLY BY USE OR PERFORMANCE OF THE PRODUCT OR ARISING OUT OF ANY BREACH OF THIS WARRANTY, INCLUDING, BUT NOT LIMITED TO, ANY DAMAGES RESULTING FROM INCONVENIENCE, LOSS OF TIME, DATA, PROPERTY, REVENUE, OR PROFIT OR ANY INDIRECT, SPECIAL, INCIDENTAL, OR CONSEQUENTIAL DAMAGES, EVEN IF RadioShack HAS BEEN ADVISED OF THE POSSIBILITY OF SUCH DAMAGES.

Some states do not allow limitations on how long an implied warranty lasts or the exclusion or limitation of incidental or consequential damages, so the above limitations or exclusions may not apply to you.

In the event of a product defect during the warranty period, take the product and the RadioShack sales receipt as proof of purchase date to any RadioShack store. RadioShack will, at its option, unless otherwise provided by law: (a) correct the defect by product repair without charge for parts and labor; (b) replace the product with one of the same or similar design; or (c) refund the purchase price. All replaced parts and products, and products on which a refund is made, become the property of RadioShack. New or reconditioned parts and products may be used in the performance of warranty service. Repaired or replaced parts and products are warranted for the remainder of the original warranty period. You will be charged for repair or replacement of the product made after the expiration of the warranty period.

This warranty does not cover: (a) damage or failure caused by or attributable to acts of God, abuse, accident, misuse, improper or abnormal usage, failure to follow instructions, improper installation or maintenance, alteration, lightning or other incidence of excess voltage or current; (b) any repairs other than those provided by a RadioShack Authorized Service Facility; (c) consumables such as fuses or batteries; (d) cosmetic damage; (e) transportation, shipping or insurance costs; or (f) costs of product removal, installation, set-up service adjustment or reinstallation. This warranty gives you specific legal rights, and you may also have other rights which vary from state to state.

RadioShack Customer Relations, 200 Taylor Street, 6th Floor, Fort Worth, TX 76102

12/99

## STORING THE EAR BUDS

1. Press the ear bud storage compartment cover's tab on the back of the radio and push in the direction of the arrow to lift the cover.
2. Insert the stereo plug into its holder and wrap the cord around the three tabs.
3. Insert the ear buds into the bottom compartment.
4. Replace the ear bud storage compartment cover.

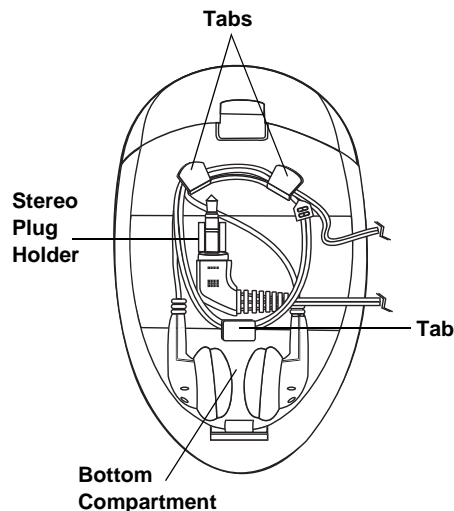

## LISTENING SAFELY

To protect your hearing, follow these guidelines when you use earbuds.

- Set the volume to the lowest setting before you begin listening. After you begin listening, adjust the volume to a comfortable level.
- Do not listen at extremely high volume levels. Extended high-volume listening can lead to permanent hearing loss.
- Once you set the volume, do not increase it. Over time, your ears adapt to the volume level, so a volume level that does not cause discomfort might still damage your hearing.

## TRAFFIC SAFETY

Do not wear the ear buds while operating a motor vehicle or riding a bicycle. This can create a traffic hazard and could be illegal in some areas.

Even though the ear buds let you hear some outside sounds when listening at normal volume levels, they still can present a traffic hazard.

## CARE

Keep the radio dry; if it gets wet, wipe it dry immediately. Use and store the radio only in normal temperature environments. Handle the radio carefully; do not drop it. Keep the radio away from dust and dirt, and wipe it with a damp cloth occasionally to keep it looking new.

If your radio is not performing as it should, take it to your local RadioShack store for assistance. Modifying or tampering with the radio's internal components can cause a malfunction and might invalidate its warranty and void your FCC authorization to operate it.

## FCC STATEMENT

Your radio might cause TV or radio interference even when it is operating properly. To determine whether your radio is causing the interference, turn it off. If the interference goes away, your radio is causing it. Try to eliminate the interference by:

- moving your radio away from the receiver.
- contacting your local RadioShack store for help.

If you can not eliminate the interference, the FCC requires that you stop using the radio.

## SPECIFICATIONS

Power Source ..... Two AAA Batteries (3V, not supplied)

FM Band ..... 88 – 108MHz

Output Power (10% THD) ..... 4mW

Accessory ..... Ear Buds with 1/8-inch (3.5 mm) Plug (supplied)

Dimensions (HWD) ..... 2<sup>3</sup>/<sub>8</sub> × 3<sup>3</sup>/<sub>4</sub> × 7<sup>7</sup>/<sub>8</sub> inches (60 × 95 × 23 mm)